

TECHSPEC® 6.0mm Diameter x 9.0mm FL, 785nm V-Coat, PCX Lens



633nm Laser Line Coated Plano-Convex (PCX) Lenses



Stock #66-263 3-4 DAYS

[Other Coating Options](#)

⊖ 1 ⊕ €46⁰⁰

ADD TO CART

Qty 1-9

€46,50

Qty 10+

€42,00

Volume Pricing

[Request Quote](#)

ⓘ Prices shown are exclusive of VAT/local taxes

Product Downloads



SPECIFICATIONS

General

Type:
Plano-Convex Lens

Physical & Mechanical Properties

Diameter (mm):
6.00 +0.0/-0.025

Centering (arcmin):
<3

Center Thickness CT (mm):
1.75 ±0.05

Edge Thickness ET (mm):
0.95

Clear Aperture CA (mm):
5.4

Bevel:
Protective bevel as needed

Optical Properties

Effective Focal Length EFL (mm):
9.00 @ 587.6nm

Back Focal Length BFL (mm):
7.95

Coating:
Laser V-Coat (785nm)

Coating Specification:
R_{abs} <0.25% @ 785nm

Substrate:
[N-SF5](#)

Surface Quality:
40-20

Power (P-V) @ 632.8nm:
1.5λ

Irregularity (P-V) @ 632.8nm:
λ/4

Focal Length Tolerance (%):
±1

Radius R₁ (mm):
6.05

f/#:
1.5

Numerical Aperture NA:
0.33

Design Wavelength DWL (nm):
785

Damage Threshold, By Design:
5 J/cm² @ 785nm, 10ns

Regulatory Compliance

RoHS 2015:
[Compliant](#)

Certificate of Conformance:
[View](#)

Reach 235:
[Compliant](#)

PRODUCT DETAILS

- <0.25% Reflection at 785nm
- BBAR Coating Options Also Available: [uncoated](#), [MgF₂](#), [VIS 0°](#), [VIS-NIR](#), [NIR I](#), [NIR II](#)
- [405nm](#), [532nm](#), [633nm](#), 785nm, [980nm](#), [1064nm](#), and [1550nm](#) V-Coated Options Offered

TECHSPEC® 785nm Laser Line Coated Plano-Convex (PCX) Lenses are designed for maximum throughput at the specified laser wavelength. These lenses are ideal for collecting and focusing light from laser sources and their corresponding harmonics. With a maximum reflection of <0.25% per surface at the design wavelength, the lenses will provide superior transmission in applications utilizing multiple optical components. TECHSPEC® 785nm Laser Line Coated Plano-Convex (PCX) Lenses are available Laser V-Coated in a range of other wavelengths: [405nm](#), [532nm](#), [633nm](#), [980nm](#), [1064nm](#), and [1550nm](#). Other coating options are available, including [uncoated](#), [MgF₂](#), [VIS 0°](#), [VIS-NIR](#), [NIR I](#), and [NIR II](#).

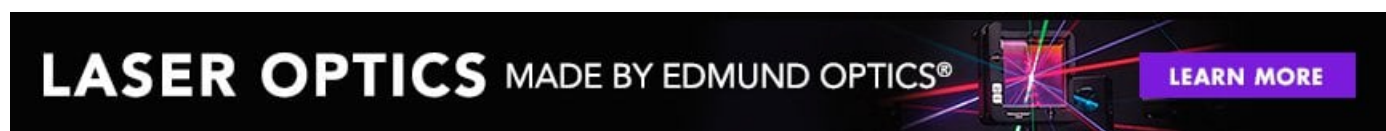

TECHNICAL INFORMATION

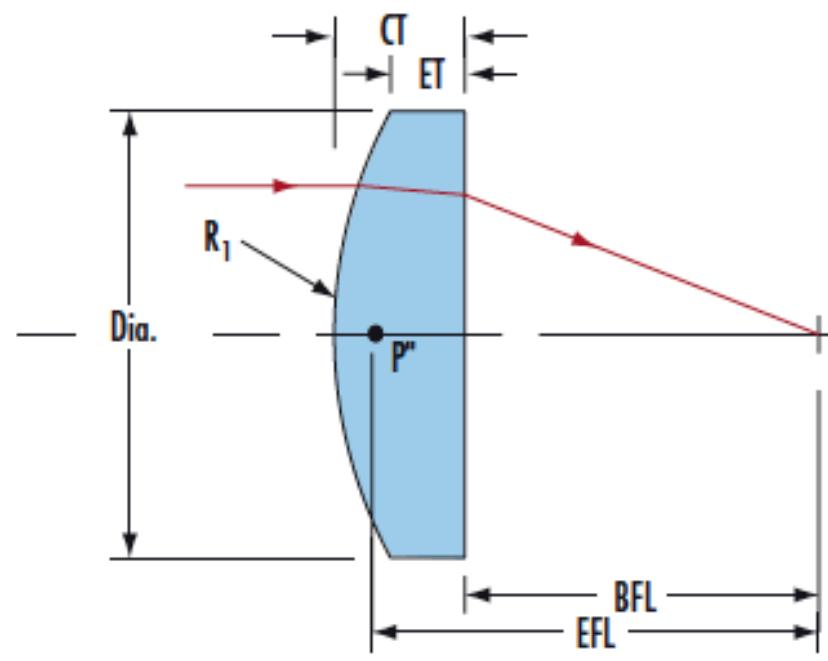

COMPATIBLE MOUNTS
