

NOTES:

1. SUBSTRATE:
SCHOTT NG4

2. FINE GRIND SURFACE

3. COATING SPECIFICATION:
S1 & S2:NONE

4. OPTICAL DENSITY: 0.5

5. TRANSMISSION (%): 31.6% AVERAGE FROM 400-700nm

6. ROHS COMPLIANT

**FOR INFORMATION ONLY:
DO NOT MANUFACTURE
PARTS TO THIS DRAWING**

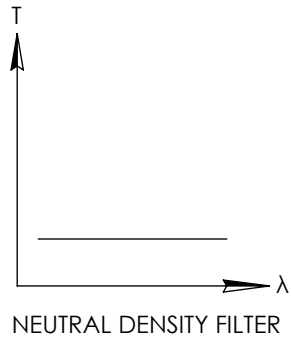
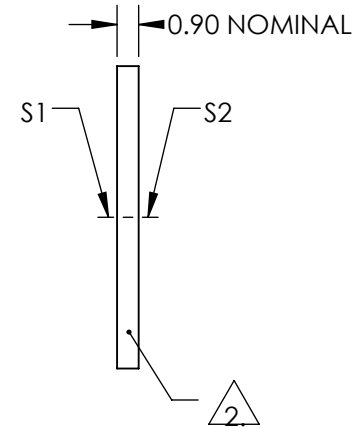
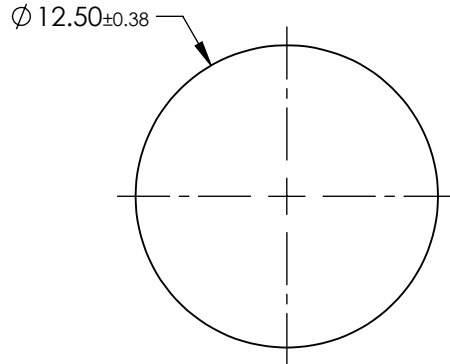
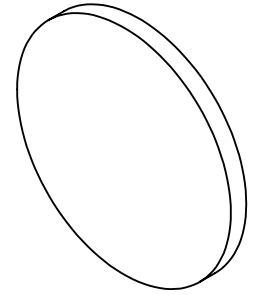

SPECIFICATIONS SUBJECT TO CHANGE WITHOUT NOTICE
DIMENSIONS ARE FOR REFERENCE ONLY

EO® Edmund Optics®

	S1	S2	THIRD ANGLE PROJECTION		TITLE	SCHOTT NG4, 0.5 OD, 12.5mm DIA., ABSORPTIVE ND FILTER	
SHAPE	PLANO	PLANO	ALL DIMS IN	mm	DWG NO	16726	SHEET 1 OF 1
SURFACE QUALITY	80-50	80-50					
BEVEL	PROTECTIVE AS NEEDED	PROTECTIVE AS NEEDED					