

NOTES:

1. SUBSTRATE
FUSED SILICA
2. SURFACE S2 TO BE PARALLEL TO SURFACE S1 TO WITHIN <3 ARCMIN
3. COATING (APPLY ACROSS COATING APERTURE):

S1: 343 HR Coating
 R (ABS) > 99.80% @ 343nm @ 45° AOI
 R (AVG) > 99.5% @ 339 - 346nm @ 45°AOI

DAMAGE THRESHOLD,
 PULSED: 6 J/cm², 20ns, 20Hz @ 343nm
 CW: 1MW/cm² @ 343nm

S2: NONE

4. FINE GRIND SURFACE
5. POWER, IRREGULARITY, AND SURFACE QUALITY SPECIFICATIONS APPLY ACROSS CLEAR APERTURE
6. CLEAR APERTURE AND COATING APERTURE ARE CENTERED ON SURFACES
7. APPLY ARROW ON EDGE WITH LASER ETCH, PENCIL, OR PERMANENT INK POINTING TOWARDS SURFACE S1

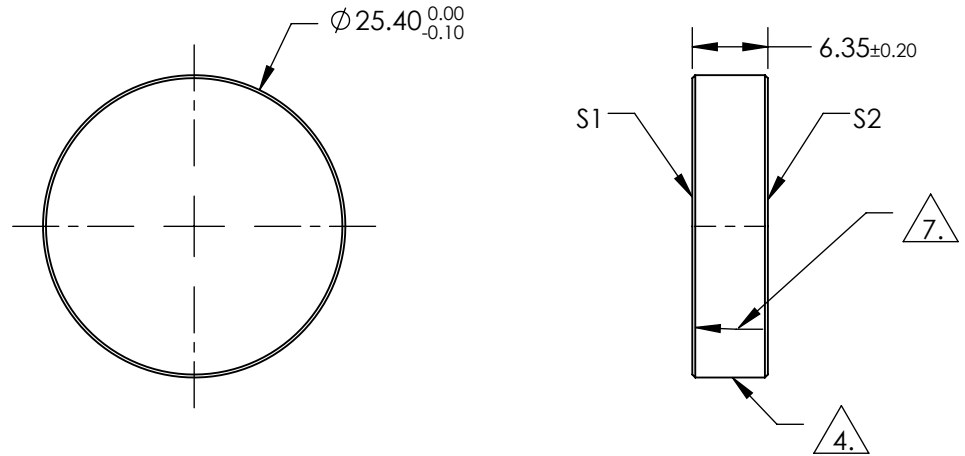

**FOR INFORMATION ONLY:
 DO NOT MANUFACTURE
 PARTS TO THIS DRAWING**

SPECIFICATIONS SUBJECT TO CHANGE WITHOUT NOTICE
 DIMENSIONS ARE FOR REFERENCE ONLY

	S1	S2
SHAPE	PLANO	PLANO
SURFACE QUALITY	10-5	COMMERCIAL POLISH
SURFACE FLATNESS	0.10 WAVE	N/A
MIN CLEAR APERTURE	Ø22.86	N/A
MIN COATING APERTURE	Ø22.86	N/A
BEVEL	PROTECTIVE AS NEEDED	PROTECTIVE AS NEEDED

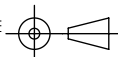
THIRD ANGLE PROJECTION 

ALL DIMS IN mm

 **Edmund Optics®**

TITLE: Ø25.4mm x 6.35mm, 343nm, Yb:YAG MIRROR
45° AOI

DWG NO: 38845

SHEET 1 OF 1