

NOTES:

1. SUBSTRATE:  
GRADE A FINE ANNEALED  
SCHOTT: N-BK7 517/642
2. ROHS COMPLIANT
3. CENTERING TOLERANCE (AT 587.6nm):  
BEAM DEVIATION (HALF ANGLE): <1 ARCMIN
4. COATING (APPLY ACROSS COATING APERTURE)  
S1 & S2:  
¼ WAVE MgF2 @ 550nm  
R(AVG) < 1.75% FROM 400-700nm (N-BK7)
5. FINE GRIND SURFACE
6. POWER, IRREGULARITY, AND SURFACE QUALITY SPECIFICATIONS APPLY ACROSS CLEAR APERTURE
7. FOCAL LENGTH (EFL): 20.00mm ±1%  
BACK FOCAL LENGTH (BFL): 19.04mm
8. PROTECTIVE BEVEL AS NEEDED
9. DESIGN WAVELENGTH: 587.6nm

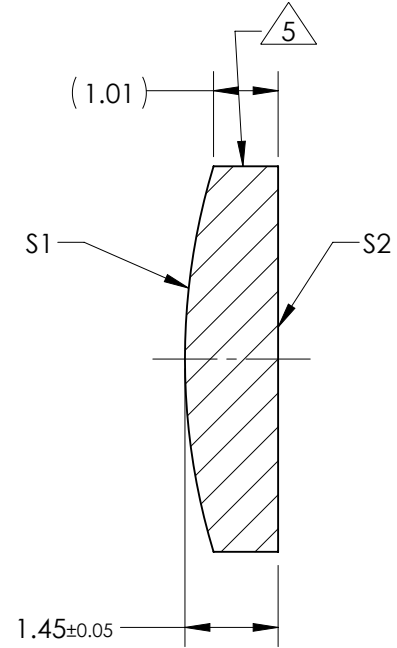
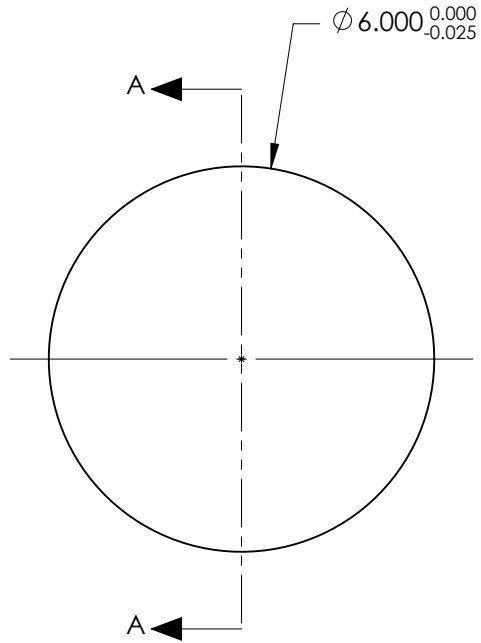

SECTION A-A

**FOR INFORMATION ONLY:  
DO NOT MANUFACTURE  
PARTS TO THIS DRAWING**

	S1	S2
SHAPE	CONVEX	PLANO
RADIUS	10.34	INFINITY
SURFACE QUALITY	40 - 20	40 - 20
MIN CLEAR APERTURE	∅ 5.40	∅ 5.40
MIN COATING APERTURE	∅ 5.00	∅ 5.00
POWER AT 632.8nm	3.00 RINGS	3.00 RINGS
IRREGULARITY AT 632.8nm	0.50 RINGS	0.50 RINGS

SPECIFICATIONS SUBJECT TO CHANGE WITHOUT NOTICE  
DIMENSIONS ARE FOR REFERENCE ONLY

**EO**® Edmund Optics®

THIRD ANGLE PROJECTION		TITLE	6.0mm Dia. x 20.0mm FL, MgF2 Coated, Plano-Convex Lens
ALL DIMS IN	mm	DWG NO	38216
			SHEET 1 OF 1