

NOTES:

1. SUBSTRATE:  
GRADE A FINE ANNEALED  
SCHOTT: N-SF11 785/258
2. ROHS COMPLIANT
3. CENTERING TOLERANCE (AT 587.6nm):  
BEAM DEVIATION (HALF ANGLE): <1 ARCMIN
4. COATING (APPLY ACROSS COATING APERTURE)  
S1 & S2: VIS-NIR  
R(ABS) ≤ 0.25% AT 880nm @ 0° AOI  
R(AVG) ≤ 1.25% FROM 400-870nm @ 0° AOI  
R(AVG) ≤ 1.25% FROM 890-1000nm @ 0° AOI
5. FINE GRIND SURFACE
6. POWER, IRREGULARITY, AND SURFACE QUALITY SPECIFICATIONS APPLY ACROSS CLEAR APERTURE
7. FOCAL LENGTH (EFL): 22.50mm±1%  
BACK FOCAL LENGTH (BFL): 20.26mm
8. PROTECTIVE BEVEL AS NEEDED
9. DESIGN WAVELENGTH: 587.6nm

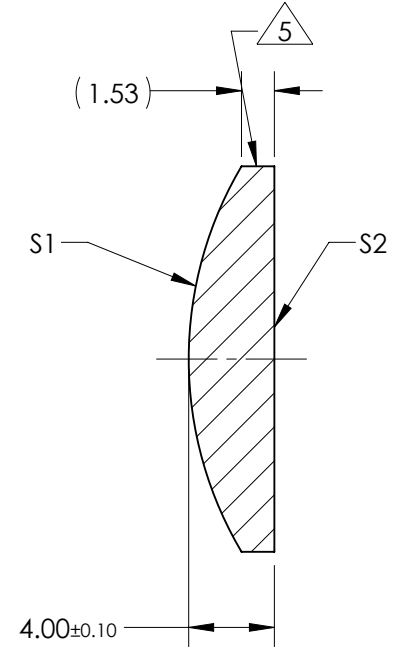
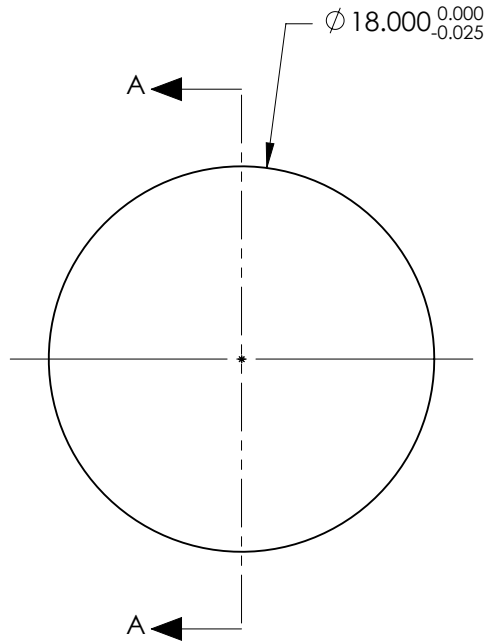

SECTION A-A

**FOR INFORMATION ONLY:  
DO NOT MANUFACTURE  
PARTS TO THIS DRAWING**

	S1	S2
SHAPE	CONVEX	PLANO
RADIUS	17.66	INFINITY
SURFACE QUALITY	40 - 20	40 - 20
MIN CLEAR APERTURE	∅ 17.00	∅ 17.00
MIN COATING APERTURE	∅ 17.00	∅ 17.00
POWER AT 632.8nm	3.00 RINGS	3.00 RINGS
IRREGULARITY AT 632.8nm	0.50 RINGS	0.50 RINGS

SPECIFICATIONS SUBJECT TO CHANGE WITHOUT NOTICE  
DIMENSIONS ARE FOR REFERENCE ONLY

**EO**® Edmund Optics®

THIRD ANGLE PROJECTION		TITLE	18.0mm Dia. x 22.5mm FL, VIS-NIR Coated, Plano-Convex Lens
ALL DIMS IN	mm	DWG NO	49920
			SHEET 1 OF 1